

Oil-free compressor stations with DürrTronic

EN



Installation and operating instructions

CE

1013100500L02



 DÜRR
TECHNIK

1901V001

Contents



Important information

1 About this document	3
1.1 Warnings and symbols	3
1.2 Copyright information	3
2 Safety	4
2.1 Intended use	4
2.2 Improper use	4
2.3 General safety information	4
2.4 Qualified personnel	4
2.5 Electrical safety	4
2.6 Only use original parts	4
2.7 Transportation and storage	5
2.8 Disposal	5



Product description

3 Overview	6
3.1 Flexible modular system	6
3.2 Examples of compressor stations	8
3.3 Accessories	9
3.4 Wear parts and replacement parts	9
4 Technical data	9
5 Pressure tank	10
5.1 Overview	10
5.2 Instructions for use for the pressure vessel (explanation by Behälter-Werk Burgau GmbH)	11
6 Declaration of conformity for machines in accordance with the 2006/42/EC Directive	12
7 Operation	13



Assembly

8 Requirements	14
8.1 Installation/setup room	14
8.2 Vibration damping between compressor unit and vessel	14
8.3 Installation position and fastening	14

8.4 Start-up cycles	14
-------------------------------	----

9 Commissioning	15
9.1 Remove the transport locks	15
9.2 Establishing the compressed air connection	15
9.3 Condensate	15
9.4 Electrical installation	15
9.5 Check of the pressure switch	16
9.6 Checking the safety valve	16
10 Adjustment options	17
10.1 Adjusting the pressure switch	17
10.2 Adjusting the motor protection switch	18
10.3 Setting the pressure reducer	19



Usage

11 Operation	20
11.1 Switching the unit on/off	20
11.2 Switching the unit on after a power cut	20
11.3 Pressure vessel test	20
12 DürrTronic	21
12.1 Product description	22
13 Taking out of use	30
13.1 Taking the unit out of use	30
13.2 Storage of the unit	30



Maintenance

14 Maintenance schedule	31
15 Replacing the air intake filter	32
16 Replace the air intake filter cartridge	32
17 Replace the vibration dampers	33
18 Replace the cylinder with cup seal	33
19 Replacing the compressor unit	34

20 DürrTronic maintenance recommendation	35
20.1 Replace the air intake filter cartridge	35
20.2 Replace the cylinder with cup seal	36
20.3 Replacing the compressor unit	37

EN



Troubleshooting

21 DürrTronic troubleshooting	39
22 Tips for operators and service technicians	40



Addresses



Important information

1 About this document

These installation and operating instructions represent a part of the unit. They correspond to the relevant version of the unit and the status of technology valid at the time of its market launch.



In the event that the instructions and notes in these installation and operating instructions for are not observed, Dürr Technik accepts no warranty or liability of any kind for the safe operation and reliable function of the units.

This translation was prepared to the best of our knowledge. The original German language version of the manual is the definitive version. Dürr Technik is not liable for translation errors.

1.1 Warnings and symbols

Warnings

The warnings in this document are intended to draw your attention to possible risks of personal injury or material damage.

The following warning symbols are used:



General warning symbol



Warning – dangerous high voltage



Warning - automatic start-up of the unit

The warnings are structured as follows:



Description of the type and source of danger

Here you will find the possible consequences of ignoring the warning

- › Follow these measures to avoid the danger.

The signal word differentiates between four levels of danger:

- **DANGER**
Immediate danger of severe injury or death
- **WARNING**
Possible danger of severe injury or death
- **CAUTION**
Risk of minor injuries
- **NOTICE**
Risk of extensive material/property damage

Other symbols

These symbols are used in the document and on or in the unit:



Note, e.g. specific instructions regarding efficient and cost-effective use of the unit.



CE labelling



De-energise the unit prior to working on it or in the event of potential danger (e.g. pull the mains plug) and prevent it from being switched back on again.



Comply with the specification in the accompanying documents.



Dispose of the unit properly and in accordance with applicable national, regional and local laws.



Dispose of the packaging material in an environmentally responsible manner.

1.2 Copyright information

All names of circuits, processes, names, software programs and units used in this document are protected by copyright.

The reprinting of the installation and operating instructions, even in extracts, is only permitted with the written permission of Dürr Technik.

2 Safety

Dürr Technik has developed and constructed the units in such a way that danger is to a large extent excluded if the units are used as intended. Nevertheless, residual risks can remain. You should therefore observe the following notes.

2.1 Intended use

The unit is intended for the compression of atmospheric air.

The unit has been designed for operation in dry, ventilated rooms. The unit must not be operated in a damp or wet environment. Its use in the vicinity of gases or flammable liquids is prohibited.

2.2 Improper use

Any other usage or usage beyond this scope is deemed to be improper. The manufacturer accepts no liability for damages resulting from improper use. In these cases the user/operator will bear the sole risk.



WARNING

Serious injury and material damage due to improper usage

- › Conveying explosive mixtures in any way other than that specified is not permitted.

2.3 General safety information

- › Always comply with the specifications of all guidelines, laws, and other rules and regulations applicable at the site of operation for the operation of this unit.
- › Check the function and condition of the unit prior to every use.
- › Do not convert or modify the unit.
- › Comply with the specifications of the Installation and Operating Instructions.
- › The Installation and Operating Instructions must be accessible to all operators of the unit at all times.

2.4 Qualified personnel

Operation

Unit operating personnel must ensure safe and correct handling based on their training and knowledge.

- › Instruct or have every user instructed in handling the unit.

Installation and repairs

- › Always arrange for any assembly work, readjustments, alterations, extensions, and repairs to be performed by Dürr Technik or by personnel authorised and trained by Dürr Technik. Qualified personnel are defined as those trained by Dürr Technik; who are familiar with the unit technology; and are aware of the dangers presented by the unit.

2.5 Electrical safety

- › Observe and comply with all the relevant electrical safety regulations when working on the unit.
- › Replace any damaged cables or plugs immediately.

2.6 Only use original parts

- › Only use accessories specified or approved by Dürr Technik.
- › Only use original working and spare parts.



Dürr Technik accepts no liability for damage resulting from the use of non-approved accessories or any non-original working or spare parts.

2.7 Transportation and storage

The original packaging provides optimum protection for the unit during transport.



Dürr Technik will not accept any responsibility or liability for damage occurring during transport due to the use of incorrect packaging, even where the unit is still under guarantee.

- Only transport the unit in its original packaging.
- Keep the packing materials out of the reach of children.



WARNING

Risk of explosion of the pressure vessel and pressure hoses

- > The pressure vessel and the pressure hoses must be vented before they are stored or transported.
- > Protect the unit from moisture during transportation.
- > Always transport the unit in an upright position.
- > Only transport the unit using the transport handles provided.
- > Do not transport the unit by the air intake filter.

The unit may be stored in its original packaging

- in warm, dry and dust-free rooms;
- protected from contaminants.



If possible, retain the packaging material.

Ambient conditions during storage and transport

Ambient conditions during storage and transport

Temperature	°C	-25 to +55
Rel. humidity	%	10 % to 90 %

Please refer to the labels on the packaging padding.

2.8 Disposal

Unit



Dispose of the unit properly and in accordance with applicable national, regional and local laws.

Packaging



Dispose of the packaging material in an environmentally responsible manner.

- Note current disposal routes.
- Keep the packing materials out of the reach of children.



3 Overview

3.1 Flexible modular system

Compressor stations with the electronic DürrTronic controller can be assembled individually from various components according to requirements.

The standard version comes ready equipped with a pressure switch, pressure gauge, safety valve, condensate drain valve and a start-up solenoid valve.

The following components are available:

- Oil-free compressor units with a delivery quantity ranging from 25 l/min to 200 l/min, equipped with single-phase AC motors or 3-phase motors.
- Different pressure vessels with a capacity of 3 l, 10 l, 25 l, 55 l or 90 l.
- A wide range of accessories such as air intake filters, quick-release couplings, pressure hoses (optional), pressure reducers (optional) etc.

Explanation of the product code

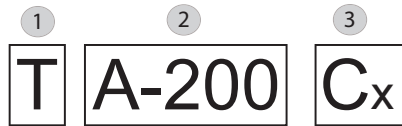

1 Vessel	
U	3 l
W	10 l
T	25 l
H	55 l
P	90 l

* Vessel with a maximum pressure (PS) of 10 bar (exception: compressor stations with 25-l vessel: PS = 8 bar)

2 Compressor units	
A	Compressor units with single-phase AC motors
B	Compressor units with 3-phase AC motors

3 Auxiliary modules	
Cx	Compressor station with DürrTronic electronic controller Contains solenoid valves for automatic condensate drainage and automatic start-up relief

The example compressor station TA-200C1 comprises:

- 25-l vessel (T)
- Compressor unit: A-200 (with single-phase AC motor)
- With DürrTronic electronic controller (C1)

3.2 Examples of compressor stations



The item numbers designate the spare parts (see "3.4 Wear parts and replacement parts").

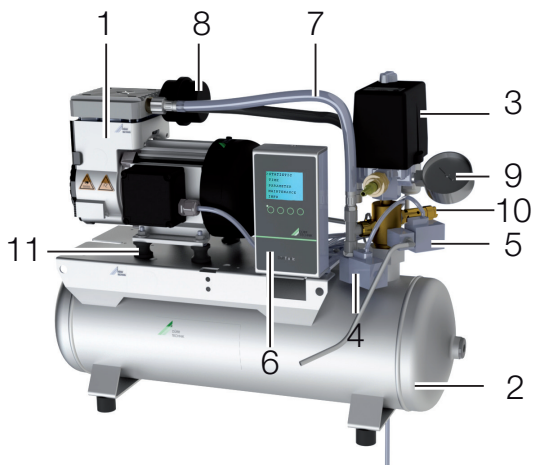

Figure 1: Layout of the WA-062Cx: Compressor unit A-062 with 10-l container (W) and DürTronic auxiliary module (electronic controller with automatic condensate drainage and automatic start-up relief)

3.3 Accessories

Accessories for compressor stations



When ordering accessories, always quote the type designation (e.g.: WA-038C1/1013200001) and the serial number.

Spare parts / accessories

Pressure reducer

Quick-release coupling
(art. no. 9000-312-03)

Hose adapter pieces for SW 10
(art. no. 9000-312-06)

Hose adapter pieces for SW 6
(art. no. 9000-311-46)

3.4 Wear parts and replacement parts

Spare parts for compressor station with membrane-drying unit



When ordering spare parts, always quote the type designation (e.g. WA-038C1/1013200001) and the serial number.

Item no. Spare parts for the compressor station

1	Compressor unit
2	Vessel without stopper
3	Pressure switch
4	Start-up solenoid valve
5	Condensate solenoid valve
7	Pressure hose
8	Air intake filter, complete
	Air intake filter cartridge
9	Pressure gauge
10	Safety Valve
11	Vibration damper
12	Condenser
15	Air evacuation hose
-	Quick-release coupling (art. no. 9000-312-03)
-	Seal
-	Complete control gear
-	Power cord

4 Technical data



For detailed information on the technical data of the compressor units, refer to the assembly and operating instructions "Oil-free piston compressors KK and piston vacuum pumps KV".

5 Pressure tank

5.1 Overview

Pressure vessels from Behälter-Werk Burgau GmbH are installed in the units.

The instructions for use given below apply to the following types of pressure vessel:

Type	Pressure ¹⁾	Vessel ²⁾	APP ³⁾	c ⁴⁾	Remark ⁵⁾
316033 / 0834-000-010	PS 8 bar	V 3 l	A	c = 1.0 mm	2
316053 / 0654-0900	PS 8 bar	V 3 l	A	c = 1.0 mm	2
316030 / 0833-320-60	PS 11 bar	V 10 l	A	c = 1.0 mm	4; 5
316034 / 5430-200-51	PS 10 bar	V 25 l	B	c = 0 mm	1; 6
316016 / 4220-200-50	PS 10 bar	V 55 l	A	c = 1.0 mm	3; 5
235791 /5450-200-90	PS 11 bar	V 90 l	A	c = 1.0 mm	4

For serial number and build year refer to the labelling on the vessel.

¹⁾ Pressure	Maximum operating pressure PS in bar
²⁾ Vessel	Vessel volume V in litres
³⁾ Application (APP)	A = Pressure vessel for compressors B = Pressure vessel for stationary systems
⁴⁾ Corrosion allowance	c in mm
Maximum temperature	+100°C
Minimum temperature	-10°C
Medium	Air/nitrogen
⁵⁾ Remark	1: The vessel is capable of sustained operation within a pressure fluctuation range of 1.6bar (10% PS). 2: The vessel is capable of sustained operation within a pressure fluctuation range of 1.6bar (20% PS). 3: The vessel is capable of sustained operation within a pressure fluctuation range of 2.0bar (20% PS). 4: The vessel is capable of sustained operation within a pressure fluctuation range of 2.2bar (20% PS). 5: The wall thicknesses must not be less than 2 mm. 6: The condensate must be drained at internal pressure in accordance with the operating instructions.
Applied standards	EN 286-1:1998

5.2 Instructions for use for the pressure vessel (explanation by Behälter-Werk Burgau GmbH)

The pressure vessel must only be used in accordance with the aforementioned intended purpose and in accordance with the specified technical data. Other forms of use are not permitted for reasons of safety. The pressure vessel has been designed in accordance with Directive 2014/29/EU and has been manufactured as a single component without safety equipment for the application area detailed above. The unit has been designed for internal pressure loads.

Before commissioning, the vessel must be fitted with the necessary safety equipment such as a pressure gauge and safety equipment designed to protect against overpressure, etc. These parts are not included in our scope of delivery.

No welding work or heat treatment may be carried out on the pressure-retaining walls of the vessel. It must be ensured that the internal pressure does not exceed the operating pressure PS specified in the labelling on the vessel during operation. However, this pressure may be temporarily exceeded by up to 10%. Vibration stress that would be damaging for the pressure vessel and corrosion on the vessel must be prevented using appropriate measures.

The assembly or installation of the pressure vessel must be carried out in such a way that safe use of the vessel is ensured (e.g. no rigid connection to the floor or machine base frame without vibration dampers).

The operating instructions to be provided by the equipment supplier must include the following information in accordance with the equipment fitted:

- a) Instructions for draining the condensate
- b) Instructions and information about maintenance to ensure safety of use

The supplier must also specify whether the pressure vessel, when fully equipped for operation, has to undergo an acceptance test before commissioning. The supplier/owner must observe the laws and regulations regarding the operation of the pressure vessel that apply in the country of operation.

The design is intended for predominantly static internal pressure loads and covers the following operating parameters: 1000 load changes from 0 to PS and capable of sustained operation within a pressure fluctuation range of 1.6 bar to 2.2 bar.

Refer to the "5.1 Overview" **Remarks**.

6 Declaration of conformity for machines in accordance with the 2006/42/EC Directive

We hereby declare that the unit described below conforms to all requirements of the machine directive 2006/42/EC.

The unit named below fulfills the requirements of the following directives:

- Electromagnetic Compatibility (EMC) Directive 2014/30/EU
- Simple pressure vessel directive 2014/29/EU
- RoHS directive 2011/65/EU

Manufacturer's name:	Dürr Technik GmbH & Co. KG
Manufacturer's address:	Pleidelsheimer Straße 30 D-74321 Bietigheim-Bissingen

Reference number:	UA-025K, WA-038..., TA-100, HB-200..., XB-304..., ZK..., AATA-100..., BBTAG-132..., CCHA-234..., DDHB-304..., SAS..., ...Cx (10132xxxxx)
Article designation:	Compressor stations / dryer stations
From the serial number:	K400000

We hereby declare that the unit may only be commissioned once it has been established that the machine into which this unit is to be installed complies with the provisions as set out in Machinery Directive 2006/42/EC.

The following harmonised standards and other standards have been applied:

- DIN EN 1012-1:2011-02
- DIN EN 60034-1:2011-02
- DIN EN 60034-5:2007-09
- DIN EN 60034-7:2001-12
- DIN EN 60034-8:2014-10
- DIN EN 60335-1:2014-11
- DIN EN 61000-3-2:2015-03
- DIN EN 61000-6-3:2012-11
- DIN EN 60204-1:2010-05
- DIN EN ISO 12100:2013-08

Bietigheim-Bissingen, 20/04/2016

Andreas Ripsam
Executive Board of Dürr Technik

Proof of signature in the
Original document held by Dürr Technik

7 Operation

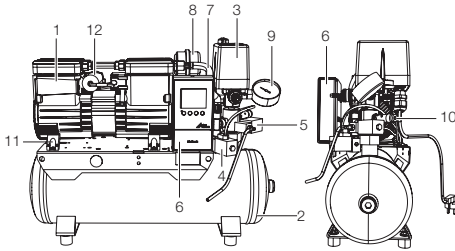

- 1 Compressor unit
- 2 Pressure vessel
- 3 Pressure switch
- 4 Start-up solenoid valve
- 5 Condensate solenoid valve
- 6 DurrTronic
- 7 Pressure hose
- 8 Air intake filter
- 9 Pressure gauge
- 10 Safety Valve
- 11 Vibration damper
- 12 Condenser*

*If included in the scope of delivery

Air is drawn in from the surrounding atmosphere through the air intake filter. This air is compressed by the piston in the cylinder. The inlet or outlet valve blocks off one of the directions of flow. The compressed air is guided through the pressure hose via the integrated non-return valve into the pressure vessel.

The compressor unit supplies compressed air until the set cut-off pressure is reached. The unit switches off. The pressure is indicated by the pressure gauge. The pressure hose is made pressureless by the integrated relief valve (on stations with a starting solenoid valve possibly not until the unit is started). If compressed air is removed for a consumer, the pressure in the vessel drops. When the switch-on pressure is reached, the compressor is switched on automatically again via the pressure switch. A safety valve prevents the maximum permissible vessel pressure from being exceeded.



8 Requirements

8.1 Installation/setup room

The room chosen for set up must fulfil the following requirements:

- Dry, well ventilated room
- Should not be a purpose-made room (e.g. boiler room or wet room)
- Set up the unit on a clean, level and sufficiently stable surface (take the weight of the unit into account).
- The socket-outlet must be easily accessible.
- The type plate of the unit must be easily readable (also after installation).
- The unit must be easily accessible for operation and maintenance.
- Once the unit has been installed, the connecting terminals must be easily accessible when removing/opening housing access.
- Maintain sufficient distance from the wall (min. 30 mm to 40 mm).

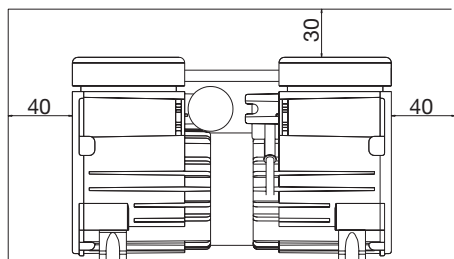
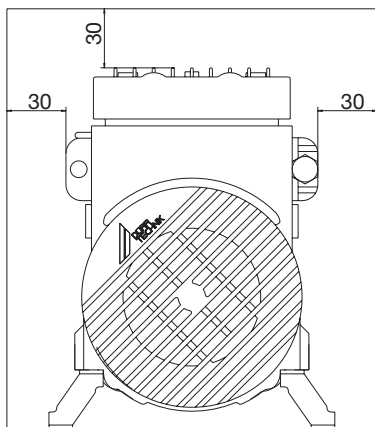

The air is filtered when it is sucked in. This does not alter the composition of the air. The source of the air taken in should be free of any harmful substances (e.g. do not draw in air from an underground garage or directly next to a suction machine).



NOTICE **Risk of overheating due to insufficient ventilation**

The units generates heat. Possibility of heat damage and/or reduced service life of the unit.

- Do not cover the unit.
- Air must be able to flow in and out unobstructed.
- Ventilation openings must be sufficiently large.
- Installed units may require an independent ventilation system in unfavourable cases.

8.2 Vibration damping between compressor unit and vessel

The unit generates vibrations. Suitable vibration dampers must be used to damp these vibrations.



CAUTION **The use of rigid connections may damage the units or the system in which the units have been installed.**

- Do not install rigid connection lines between unit and system.

8.3 Installation position and fastening

Install the units as near as possible to the horizontal. Other fitting positions must be agreed in advance with Dürr Technik.

8.4 Start-up cycles

The motors in the compressor stations are designed for 10 starts/stops per hour. More frequent switching will lead to increased wear.

9 Commissioning

9.1 Remove the transport locks

The unit is securely protected with packaging material to ensure safe transportation.

- › Remove the packaging material.
- › Remove the protective film.
- › Check the unit for damage in transit.

9.2 Establishing the compressed air connection

 The devices are designed as standard for a nominal pressure of 7 bar. Exceeding the nominal pressure on a regular basis will reduce the service life of the device.

The unit is equipped as standard with a control gear, which consists of a pressure switch, pressure gauge, safety valve, non-return valve and condensate drain.

In order to avoid the transfer of vibrations, we recommend installing a flexible pressure hose between the pressure hose and the pressure switch. A pressure reducer can also be connected.

- › The compressed-air supply is connected to the quick-release coupling (incl. hose adapter piece) or to the pressure switch by means of a G 1/4" internal thread.
- › Secure the pressure hose to the hose adapter piece using a hose clip.
- › Connect the hose adapter piece to the quick-release coupling.

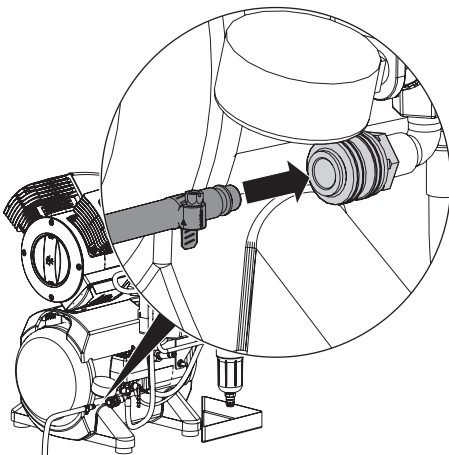



9.3 Condensate

During operation, condensed water is continuously separated off in the compressor station.

-  The condensate can be drained through a hose into the waste water system.
- › Fasten the condensate drain hose to the unit and secure it so that it cannot slip out.
- › Secure the condensate drain hose by guiding it or fastening it to the drain.

9.4 Electrical installation

 For detailed information on electrical installations refer to the assembly and operating instructions "Oil-free piston compressors KK and piston vacuum pumps KV".

 If the unit is transported from a very cold environment to a very warm one, condensation water can collect on the PCB. Wait one hour before switching on the unit.

Electrical connection using a mains plug

- › The unit may only be connected to a correctly installed socket outlet.
- › Make sure that none of the electrical cables leading to the unit are under any mechanical tension.
- › The socket-outlet must be easily accessible.
- › Before commissioning, verify that the power supply voltage complies with the voltage specifications of the model identification plate.



DANGER

Risk of electric shock due to defective power cord

- › The power cord must not be allowed to come into contact with any hot surfaces on the unit.
- › Route power cords without mechanical tension.
- › Connect the mains plug to an earthed socket outlet.
- › The unit will start immediately after connection of the mains plug.

Electrical connection without a mains plug



DANGER
Connection to the power supply may only be performed by a qualified electrician.

- › Switch on the unit at the pressure switch and fill the pressure vessel to the cut-off pressure.
- › Rotate the cap of the safety valve a few turns anti-clockwise until the valve begins to blow off. Only allow the safety valve to blow for a short period.
- › Turn the cap clockwise as far as it will go.

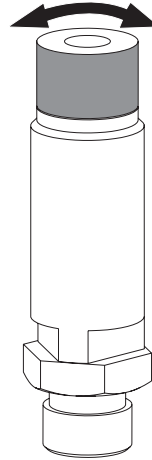

The valve is closed.

9.5 Check of the pressure switch

The cut-off pressure is generally set to 7 bar (0.7 MPa).

- › Switch on the device at the pressure switch by rotating the switch to the "I" position.
- › Read off the cut-off pressure from the pressure gauge.

If the value read from the pressure gauge differs from the factory setting, the pressure switch can be adjusted (see "10.1 Adjusting the pressure switch").

9.6 Checking the safety valve

The safety valve must be checked to establish that it is working correctly when the unit is started up for the first time.



At the factory, the safety valve is set to 10 bar (1 MPa) or 8 bar (0.8 MPa) (depending on the maximum pressure), inspected and stamped (see also "5.1 Overview").



DANGER
Explosion of the pressure vessel and pressure hoses

- › Do not change the safety valve settings.



WARNING
Risk of damage to the safety valve

Risk of explosion of the pressure vessel and pressure hoses due to a defective safety valve

- › Do not use the safety valve to vent the pressure vessel.

10 Adjustment options

10.1 Adjusting the pressure switch



DANGER

Explosion of the pressure vessel

If the specified pressure fluctuation range is exceeded there is a risk of explosion.

- › Make sure that the specified maximum pressure fluctuation range is not exceeded – see "5.1 Overview"



DANGER

Exposed live parts

Risk of electric shock due to live parts

- › Unplug the unit from the socket-outlet.
- › Use insulated tools.
- › Do not touch live parts.



The cut-off pressure must be at least 0.5 bar (0.05 MPa) below the maximum pressure of 10 bar (1 MPa) or 8 bar (0.8 MPa) (depending on the maximum pressure) of the safety valve. Otherwise the safety valve can open too early, which will prevent the compressor unit from attaining the cut-off pressure, and as a result it will run continuously. The maximum pressure is marked by a red line on the attached pressure gauge.



The adjustment of the pressure switch must be performed under pressure. The code for the pressure switch (MDR3 or MDR2) can be found on the pressure switch cover.

Adjustment of the MDR3

If the read-off values differ from the factory settings or if other settings are required, the cut-off pressure of the compressor can be adjusted at the setting screw on the pressure switch. The switch-on pressure can then be adjusted using the pressure differential Δp .

- › Take off the pressure switch cover.

- › Adjust the cut-off pressure p using the setting screw.

The cut-off pressure increases in the "+" arrow direction and decreases in the "-" arrow direction. The pressure differential Δp is also influenced by this adjustment.

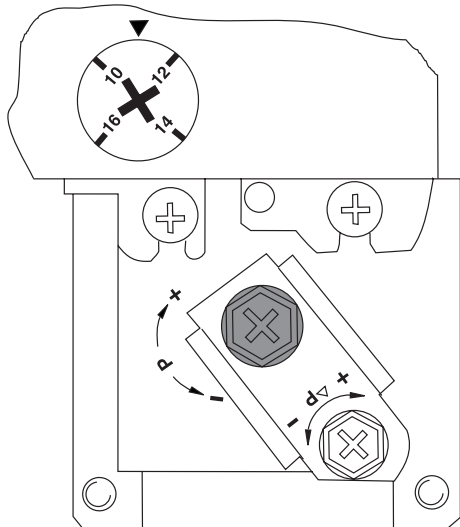

- › Use the setting screw to readjust the pressure differential Δp between the switch-on pressure and the cut-off pressure.

The pressure differential increases in the "+" arrow direction and decreases in the "-" arrow direction.

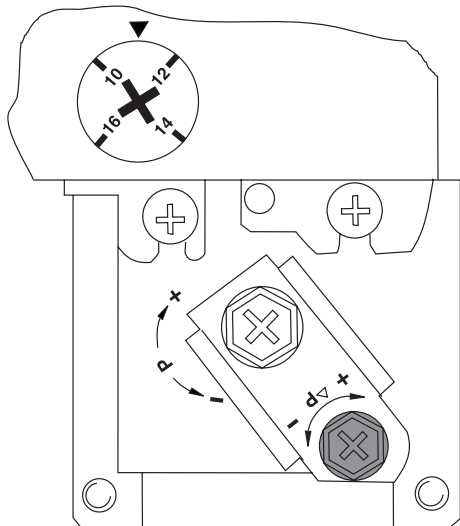

Adjustment of the MDR2

If the read-off values differ from the factory settings or if other settings are required, the cut-off pressure of the compressor can be adjusted at the setting screw on the pressure switch. The switch-on pressure can then be adjusted using the pressure differential Δp .

- › Undo the fixing screws in the pressure switch cover.
- › Take off the pressure switch cover.
- › Adjust the cut-off pressure p using the two setting screws (1).

The cut-off pressure increases in the "+" arrow direction and decreases in the "-" arrow direction.

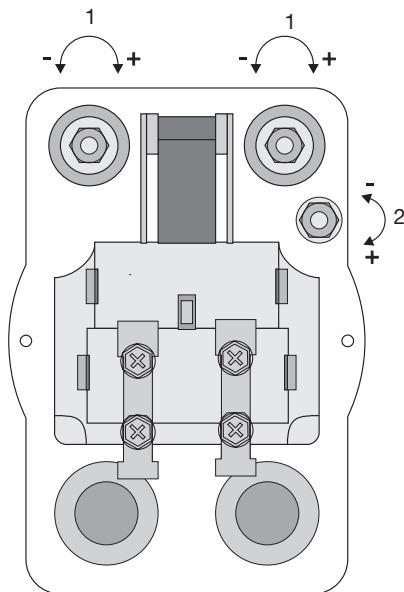

- › The pressure differential Δp between the switch-on pressure and the cut-off pressure is set using the setting screw (2).

Turning the screw in the arrow direction "+" increases the pressure differential (lower switch-on pressure), while turning it in the arrow direction "-" decreases the pressure differential (higher switch-on pressure).

10.2 Adjusting the motor protection switch

 Not all units have a motor protection switch.

- › The motor protection switch is adjusted and marked at the factory.
- › Take off the pressure switch cover.
- › Adjust the motor protection switch with the setting screw according to the motor current (note the range between min. permissible setting and max. permissible setting of the motor protection switch).

The max. permissible motor current is the current rating on the type plate +10%.

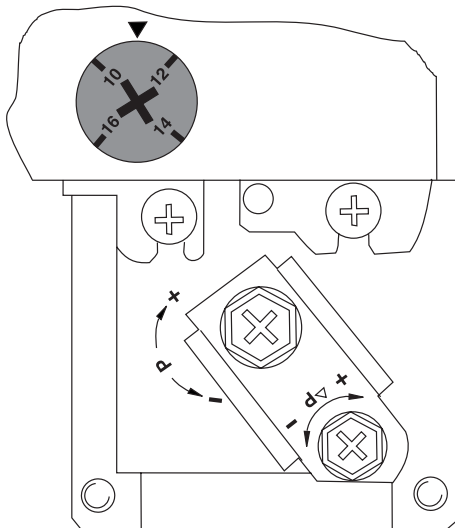

10.3 Setting the pressure reducer

The pressure reducer (optionally available) regulates the vessel pressure (primary pressure) to the required operating pressure (secondary pressure). An increase of pressure when the consumer is switched off is prevented by an additional secondary vent. The pressure reducer is mounted on the pressure switch (G1/4").

Adjusting the pressure reducer:

- › Pull up the adjuster knob (1).
- › **To increase the supply pressure:** Turn the adjuster knob (1) clockwise towards "+".
- › **To decrease the supply pressure:** Turn the adjuster knob (1) anti-clockwise towards "-".
- › Once you have reached the required supply pressure (this can be read from the pressure gauge (2)), push the adjuster knob (1) down until it clicks into place.
- › Check the supply pressure on the pressure gauge (2).

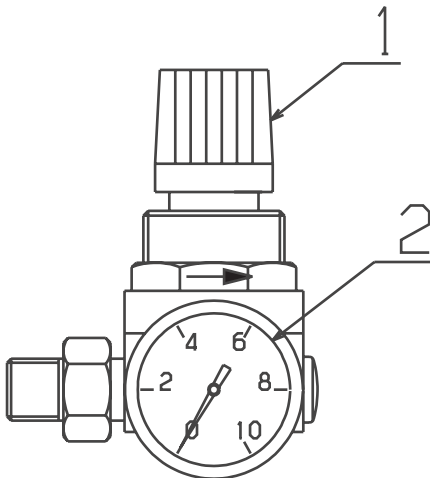

- 1 Adjuster knob
- 2 Pressure gauge



11 Operation



De-energise the unit prior to working on it or in the event of potential danger (e.g. pull the mains plug) and prevent it from being switched back on again.

11.1 Switching the unit on/off

- › Switch on the device at the pressure switch by rotating the switch to the "I" position.

The compressor unit will start up automatically and fill the pressure vessel. When the cut-off pressure is reached, the compressor unit switches itself off automatically.

- › The unit can be switched off whenever required by turning the pressure switch to the "0" setting.

11.2 Switching the unit on after a power cut

The unit is equipped with an automatic start-up solenoid valve that allows the unit to start up without being pressurised.

11.3 Pressure vessel test



The owner must comply with the national directives.

Example for Germany: German Ordinance on Industrial Safety and Health (BetrSichV)

12 DürrTronic

The DürrTronic electronic controller is a component of the compressor station. It is designed to monitor the most important operating parameters of compressor stations.

It registers operating hours and the duration of switch-on cycles, informs of necessary maintenance steps and warns the operator if the unit is overloaded from too many switch-on cycles per hour. In addition, it takes over control of the solenoid valves. The DürrTronic electronic controller is equipped with a GUI (graphical user interface).

12.1 Product description

Operating elements

EN



- 1 Status bar
- 2 Information area
- 3 Navigation bar
- 4 Buttons

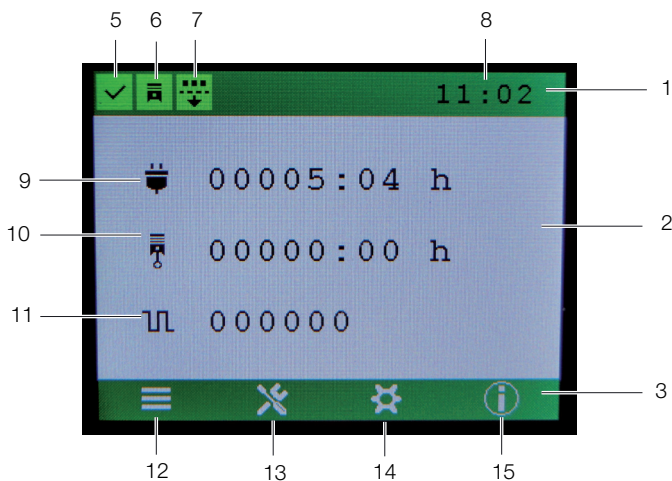







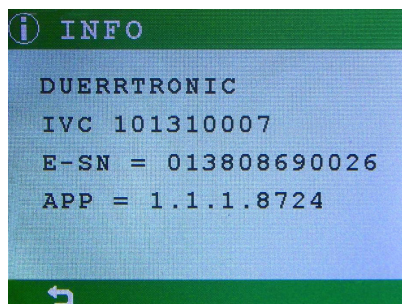





















- 1 Status bar
- 2 Information area
- 3 Navigation bar
- 4 -
- 5 Status of device
- 6 Status of cup seal
- 7 Status of air intake filter
- 8 Time
- 9 Mains operation in hours
- 10 Operating hours
- 11 Number of motor start cycles
- 12 Main menu
- 13 Maintenance
- 14 Settings
- 15 Information

Version

Press the  button to switch the information display to the "INFO" submenu. Here you can call up the serial number E-SN of the electronic controller and the software version (APP).



Symbols used in the display

Symbol	Description
	Menu
	Maintenance
	Settings
	Information
	Mains operation in hours
	Operating hours
	Number of motor start cycles
	Cup seal / status
	Filter / status
	Device / status
	Warning message yellow
	Alarm message red
	Diagnostic
	Time
	Home
	Statistics
	Back
	Save data
	Edit data
	Replace
	Plus
	Minus
	On
	Off
	"Up" arrow
	"Down" arrow
	"Right" arrow
	Confirm input

Initial commissioning

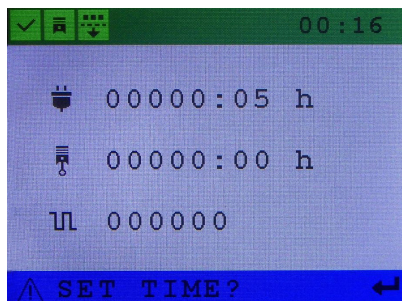

When the station is connected to the mains, the prompt "SET_TIME" is shown in the navigation bar of the start screen.

>

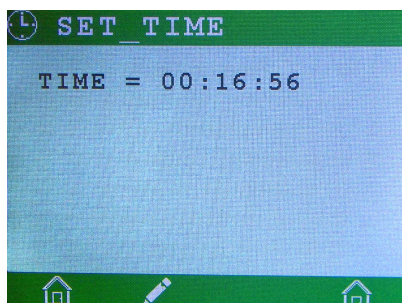

> Press the  button to switch the information display to the "SET_TIME" submenu







> Press the  button to switch the navigation bar into the setup mode. Press the  and  buttons to set the current time.

> Press the  button to confirm the time.

Navigation bar

Navigation bar in the start screen





The navigation bar (3) displays menu icons (buttons) that can be activated by pressing a button. The following menus can be called up from the navigation bar on the start screen:

Menus - start screen	Description
	Menu
	Maintenance
	Settings
	Information

Navigation bar in the menu

If a menu is switched to from the start screen, the navigation bar (3) changes.

The icons in the navigation bar permit scrolling through the submenu, confirming an entry, or returning to a previous menu:

Icons - menu	Description
	Back to the preceding menu option
	"Up" arrow
	"Down" arrow
	Confirm input
	The Home button returns to the start screen

Navigation bar for warning/ alarm messages



Changes to the device status or warning message / alarm message (see "Warning / alarm message") on the maintenance intervals are also displayed in the navigation bar.

Status bar

Start screen status bar

The status bar (1) shows the following status information in the start screen:

- Device status
- Status of cup seal
- Status of air intake filter
- Time



Status display	Description
	Status: "device status green" The device is ready for operation and is working properly.
	Status: "cup seal green" Cup seal is in good condition.
	Status: "air intake filter green" Air intake filter cartridge is in good condition.

 If the status displays change their colour to yellow or red, see "Warning / alarm message"

Submenu status bar

If a submenu is called up from the navigation bar of the start screen, this submenu is displayed in the status bar (1).

Some examples:

Submenu	Description
 MAINTENANCE	Maintenance submenu
 PARAMETER	Settings submenu
 INFO	Information submenu

Info area menu navigation

Menu navigation with "main menu" as an example

- › In the navigation bar (start screen), press the button, e.g. "Main menu" .
- › The info area of the start screen switches to the "main menu".

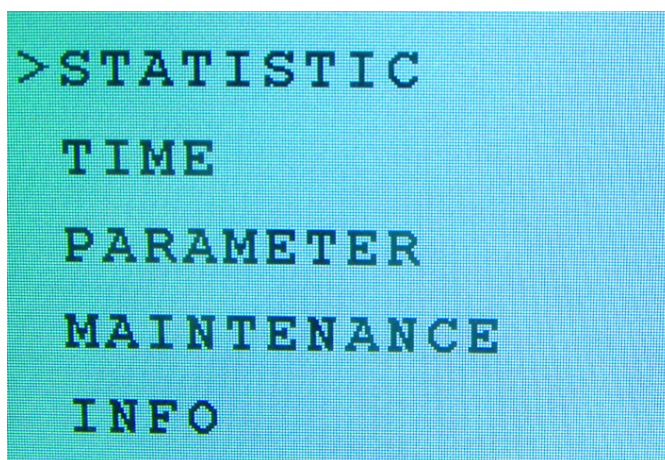





Figure 2: "Main menu" info area

Through the navigation bar, the desired submenu can be selected with the "down" and "up" arrow buttons  and .

The marking  displays which submenu was selected. Pressing the "Entry" button  switches the display to the selected submenu.

The info area switches to the submenu, e.g. STATISTIC

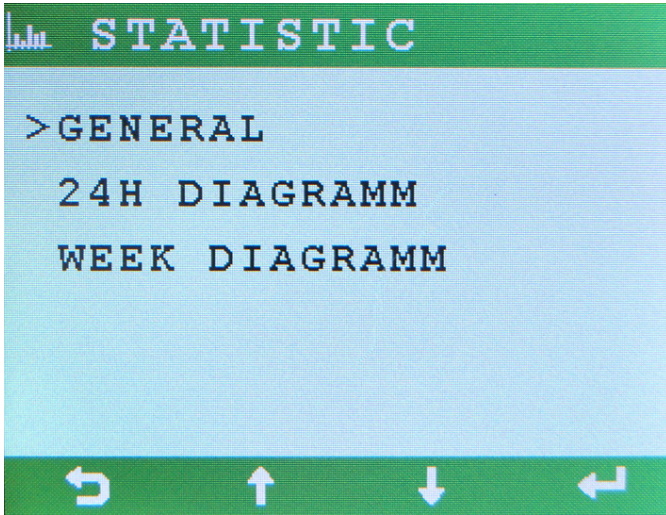



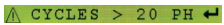





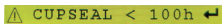







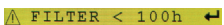







Figure 3: Info area of "Statistic" submenu

- › The "Back" button  returns the display to the preceding menu.

Warning / alarm message

Warning / alarm messages

If a warning or alarm message appears in the navigation bar, manual intervention is required.

Warning / alarm messages	Action steps
	<p>Warning message: Start / stop cycles per hour* are exceeded (over 20 start / stop cycles per hour).</p> <p>Pressing the entry button  makes the display disappear from the navigation bar.</p> <p>In the status bar, the green symbol for the device status  changes to a yellow symbol .</p> <p>The yellow symbol automatically changes back into the green symbol if no start/stop cycles are exceeded in the next 24 hours.</p>
	<p>Alarm message: Start / stop cycles per hour* are exceeded (over 30 start / stop cycles per hour) and are in the critical range.</p> <p>In the status bar, the yellow symbol for the device status  changes to a red symbol .</p> <p>The red symbol automatically changes back into the green symbol if no start/stop cycles are exceeded in the next 24 hours.</p>
	<p>Warning message: The cup seal should be replaced within the next 100 operating hours.</p> <p>Pressing the entry button  makes the display disappear from the navigation bar.</p> <p>In the status bar, the green symbol for the cup seal  changes to a yellow symbol .</p>
	<p>Alarm message: The cup seal must be replaced</p> <p>Pressing the entry button  makes the display disappear from the navigation bar.</p> <p>In the status bar, the yellow symbol for the cup seal  changes to a red symbol .</p> <p>The cup seal must be replaced.</p>
	<p>Warning message: The air intake filter cartridge should be replaced within the next 100 operating hours</p> <p>Pressing the entry button  makes the display disappear from the navigation bar.</p> <p>In the status bar, the green symbol for the air intake filter cartridge  changes to a yellow symbol .</p>
	<p>Alarm message: The air intake filter cartridge must be replaced</p> <p>Pressing the entry button  makes the display disappear from the navigation bar.</p> <p>In the status bar, the yellow symbol for the air intake filter cartridge  changes to a red symbol .</p> <p>The air intake filter cartridge must be replaced.</p>

* The maximum recommended number of start / stop cycles for the motor is 10 start /stop cycles per hour. More than 10 start / stop cycles per hour increase wear on the device and shorten its service life.

13 Taking out of use

13.1 Taking the unit out of use

If the unit is not to be used for a prolonged period of time, we recommend that it is properly shut down and taken out of use.

To do this, the accumulated condensation water from the unit must be drained.

- › Switch on the unit and wait until the cut-off pressure is reached.

Unit with condensate separator

- › At maximum tank pressure, unscrew the bottom screw fitting on the condensate separator.
- › Close the screw connection as soon as all of the condensate has been blown out.

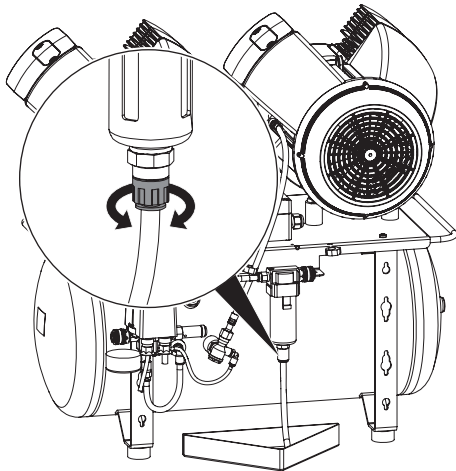

Pressure tank

- › Switch off the unit.
- › Disconnect the mains plug.
- › Relieve the full pressure from the compressed air vessel (e.g. using a blow-off gun connected to the quick-release coupling or via the condensate drain valve (if present)).
- › Disconnect the compressed air connection on the quick release coupling.

13.2 Storage of the unit



WARNING

Risk of explosion of the pressure tank and pressure hoses

- › The pressure tank and the pressure hoses must be vented before they are stored or transported.

- › Protect the unit against moisture, dirt and extreme temperatures during transport (refer to the section on "Ambient conditions").
- › Only store the unit when it has been completely emptied.



De-energise the unit prior to working on it or in the event of potential danger (e.g. pull the mains plug) and prevent it from being switched back on again.

14 Maintenance schedule

Maintenance interval	Maintenance work
Every six months	› Check the safety valve (see "9.6 Checking the safety valve").
Annually	› Replace the air intake filter – if there is a high concentration of dust, this must be carried out every six months (see "16 Replace the air intake filter cartridge").
Every 4 years	› Replace the vibration dampers.
In accordance with national directives	› Carry out recurring safety tests (e.g. pressure vessel testing, electrical safety testing) in accordance with the national directives.
Observe the assembly and operating instructions "Oil-free piston compressors KK and piston vacuum pumps KV"	› Maintenance of the compressor unit

15 Replacing the air intake filter

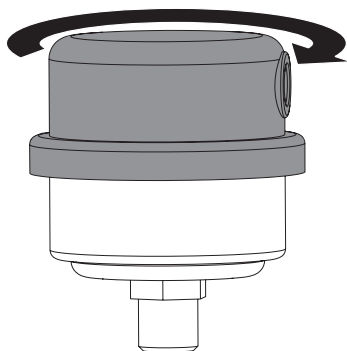

- › Open the cover of the air intake filter by turning it clockwise.
- › Remove the filter element (white/green).
- › Insert a new filter element.
- › Close the cover of the air intake filter by turning it anti-clockwise

16 Replace the air intake filter cartridge

- › Open the cover of the air intake filter by turning it clockwise.
- › Take out the air intake filter cartridge.

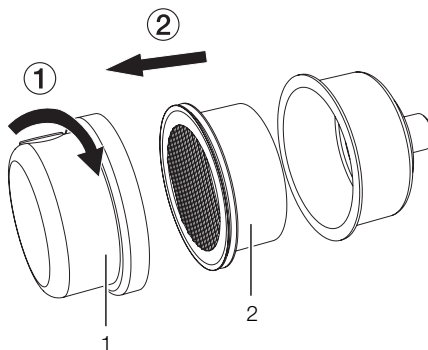

- 1 Air intake filter lid
- 2 Intake filter cartridge

- › Insert a new air intake filter cartridge.
- › Close the cover of the air intake filter by turning it anti-clockwise.

17 Replace the vibration dampers

Follow the installation instructions included in the relevant spare parts set.

18 Replace the cylinder with cup seal

Follow the installation instructions included in the relevant spare parts set.



Any repairs exceeding routine maintenance may only be carried out by qualified personnel or our service.

19 Replacing the compressor unit



NOTICE

Damage to the unit due to faulty assembly

Replacing the spare parts requires specialist knowledge. Faulty assembly will result in unit outage.

- › Repairs must only be performed by Dürk Technik or by personnel trained by Dürk Technik.

20 DürrTronic maintenance recommendation

20.1 Replace the air intake filter cartridge







The preset maintenance interval has been determined based on many years of experience and serves as a recommendation.

Depending on the setup conditions and use of the device (e.g. clean / dusty surrounding air, ambient temperature, temperature fluctuations, switch-on cycles, etc.), the actual maintenance interval can deviate from the recommendation.

This is not a reason for complaint.

If the red alarm message appears in the navigation bar for changing the air intake filter cartridge

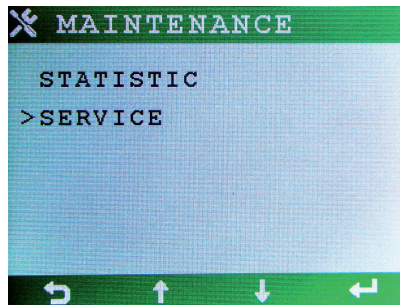

 **FILTER REPLACE** , the air intake filter cartridge must be changed.

- > Pressing the entry button  makes the display disappear from the navigation bar. In the status bar, the yellow symbol for changing the air intake filter cartridge  changes to a red symbol .
- > The air intake filter cartridge must be changed in accordance with the maintenance and repair instructions, which accompany the spare parts set.
- > After the air intake filter cartridge is changed, pressing the maintenance button  switches the display to the maintenance submenu.







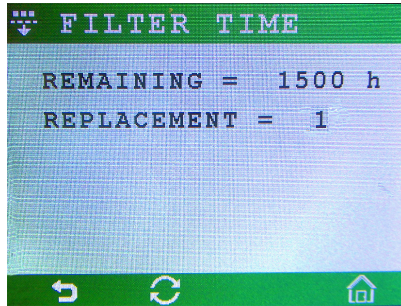

- > The "down" arrow button  marks the "SERVICE" submenu (see indicator ) , and pressing the enter button  changes to that submenu.



- > The "down" arrow button  marks the "FILTER" submenu (see indicator ) , and pressing the enter button  changes to that submenu.



- > The replacement of the air intake filter cartridge is confirmed by pressing the "Replacement" button .
- > This is followed by the safety prompt  RESET TIME? . This is confirmed by pressing the enter button . The operating time counter is reset to its original value (REMAINING = 1500 h). The number of replacement procedures is counted upwards in the "REPLACEMENT" field. The red alarm message in the status bar for changing the air intake filter cartridge  changes to the green status .

20.2 Replace the cylinder with cup seal

-  The preset maintenance interval has been determined based on many years of experience and serves as a recommendation.



Depending on the setup conditions and use of the device (e.g. clean / dusty surrounding air, ambient temperature, temperature fluctuations, switch-on cycles, etc.), the actual maintenance interval can deviate from the recommendation.

This is not a reason for complaint.

If the red alarm message appears in the navigation bar for changing the cylinder / cup seals



-  CUPSEAL REPLACE , the friction pairing must be changed.

- > Pressing the entry button  makes the display disappear from the navigation bar.

In the status bar, the yellow symbol for changing the cylinder / cup seals  changes to a red symbol .

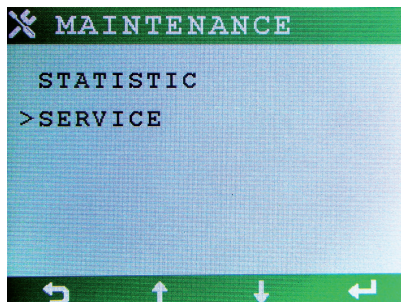
- > The cylinder/cup seal must be replaced in accordance with the maintenance and repair instructions, which accompany the spare parts set.
- > After the cylinder/cup seal is changed, pressing the maintenance button  switches the display to the maintenance submenu.





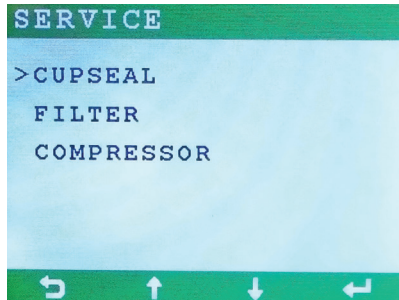

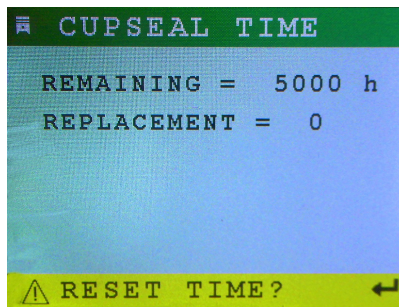

- › The "down" arrow button  marks the "SERVICE" submenu (see indicator ) , and pressing the enter button  changes to that submenu.



- › The "CUPSEAL" submenu is marked (see indicator ) , and pressing the input button  changes the display to this submenu.



- › The replacement of the cylinder/cup seal is confirmed by pressing the "Replacement" button .
- › This is followed by the safety prompt  RESET TIME? . This is confirmed by pressing the enter button . The operating time counter is reset to its original value (REMAINING = 5000 h). The number of replacement procedures is counted upwards in the "REPLACEMENT" field. The red alarm message in the status bar for cylinder/cup seal  changes to the green status .

20.3 Replacing the compressor unit

The replacement of the compressor unit must only be performed by Dürr Technik or by personnel trained by Dürr Technik (see "19 Replacing the compressor unit").

- › After the compressor unit has been replaced, switch to the "SERVICE" submenu in the navigation bar by pressing the service button .



- > The "down" arrow button ↓ marks the "SERVICE" submenu (see indicator >), and pressing the enter button ↵ changes to that submenu.

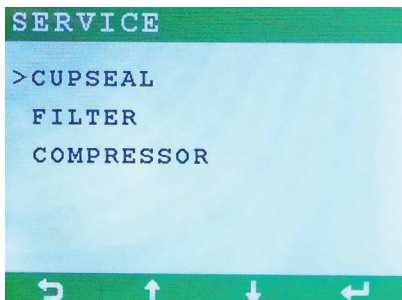

- > The "down" arrow button ↓ marks the "SERVICE" submenu (see indicator >), and pressing the enter button ↵ changes to that submenu.

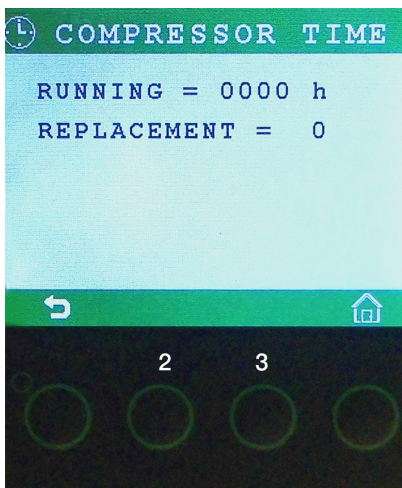

- > Press buttons 2 and 3 simultaneously – the safety prompt ⚠ RESET TIME? ↵ is displayed.

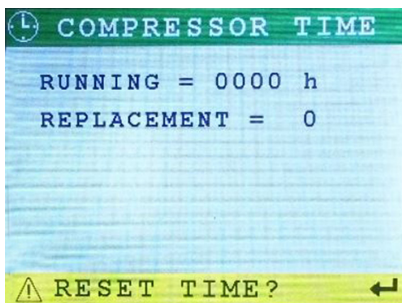

- > This is confirmed by pressing the enter button ↵. The RUNNING TIME is reset to 0000 h (RUNNING = 0000 h). The number of replacement procedures is counted upwards in the "REPLACEMENT" field.



21 DürrTronic troubleshooting

If you have questions on operating the DürrTronic, the Dürr-Technik service department is available to help (see see "Addresses" on page 42).

22 Tips for operators and service technicians



For further information on trouble-shooting refer to the assembly and operating instructions "Oil-free piston compressors KK and piston vacuum pumps KV".



Any repairs exceeding routine maintenance may only be carried out by qualified personnel or our service.



De-energise the unit prior to working on it or in the event of potential danger (e.g. pull the mains plug) and prevent it from being switched back on again.

Fault	Probable cause	Solution
Unit does not start	No power supply voltage	› Inform an electrician. Check mains fuse and if possible, switch on unit again. If the safety fuse is defective, replace it.
	Undervoltage or overvoltage	› Inform an electrician. Measure power supply voltage.
	Condensor defective	› Notify electrician/engineer. Check condensor and replace if necessary.
	Motor defective	› Replace the unit.
	Temperature switch in the motor (not fitted in all units) has switched off 1.High ambient temperature 2.Mechanical sluggishness 3.Pressure in the line	1.Allow the unit to cool down. Ensure better cooling. Warning: unit restarts automatically. 2.Factory repair. 3.Evacuate air from the suction volume.
	Air intake filter cartridge blocked	› Insert a new air intake filter cartridge.

Fault	Probable cause	Solution
Output drops.	Lines, hoses or connections leaking	› Inform a service technician. Check / renew lines, hoses or connections.
	Defective membrane-drying unit	› Inform a service technician. Replace the membrane-drying unit.
	Air intake filter soiled	› Replace the air intake filter at least 1x per year. The air intake filter must never be cleaned.
	Head kit leaking as a result of wear and/or for one or more of the following reasons: – Soiling – Excessive ambient temperature – Unsuitable materials drawn in	Inform a service technician. Replace the head kit. – Install the filter upstream or replace the filter. – Ensure that cooling is more effective. – Only convey approved materials.
	Defective valve plate	› Inform a service technician. Replace the valve plate.
	Too frequent switching cycles	› Avoid switching on/off too frequently, or work with a larger compressed-air vessel.
Unit too noisy	Bearing damaged	› Inform a service technician.
	Vibrations are being transmitted to the housing	› Use suitable vibration dampers.
	Defective vibration dampers	› Install new vibration dampers.
Water dripping from air consumers	Compressor stations with membrane drying unit: Membrane-drying unit defective	› Inform a service technician. Replace the membrane-drying unit.
	Compressor stations without membrane drying unit: Condensed water in the vessel	› Regularly drain the condensed water.
Pressure dew point is not correct	Purge air nozzle too large or small	› Inform a service technician. Replace the purge air nozzle.
Moisture indicator on membrane drying unit is pink	Unit has not been used for a extended period of time	› When the unit is operated, the moisture indicator will regenerate itself and turn blue again.
	During operation: malfunction of the membrane-drying unit. Air drying insufficient	› Inform a service technician. Replace the membrane-drying unit.



Service

Dürr Technik GmbH & Co. KG
74301 Bietigheim-Bissingen
Telephone +49 (0) 71 42 / 90 22 - 20
Fax +49 (0) 71 42 / 90 22 - 99
email: service@duerr-technik.de

Replacement

Telephone +49 (0) 71 42 / 9022 - 0
Fax +49 (0) 71 42 / 9022 - 99
email: office@duerr-technik.de

The following information is required when ordering spare parts:

- Type designation and item number
- Order number as appears on the spare parts list
- Quantity required
- Exact shipping address
- Shipping information

Repairs/return delivery

Ensure that the unit is **depressurized** before transport! Use the original packaging when returning units, if possible. Always pack the units in a plastic bag. Use recyclable packing material.

Return delivery address:

Dürr Technik GmbH & Co. KG
Pleidelsheimer Straße 30
74321 Bietigheim-Bissingen
-Germany-

International addresses for Dürr Technik

www.duerr-technik.com

Dürr Technik GmbH & Co. KG
Pleidelsheimer Strasse 30
74321 Bietigheim-Bissingen
Germany
Fon: +49 7142-90 22 -0
www.duerr-technik.com
office@duerr-technik.de

